

TPP74Q

Punta per guida in alluminio

CNC router bit for aluminium guides



CODICE CODE	D mm	B mm	A/L mm	Z	Rif.
TPP74Q.001	27	27	Ø20X50	1	A
TPP74Q.002	30.1	27	Ø20X50	1	B
TPP74Q.003	25.8	27	Ø20X50	1	C
TPP74Q.004	27	27	Ø20X50	1	D
TPP74Q.005	27	27	Ø20X50	1	E
TPP74Q.006	24.2	27	Ø20X50	1	F

Un profilo a scelta / A profile to choice



Utensile collaudato
secondo la normativa
Tool tested
according to the norm

EN 847-1

A

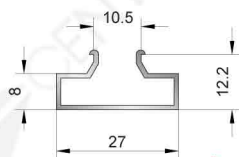
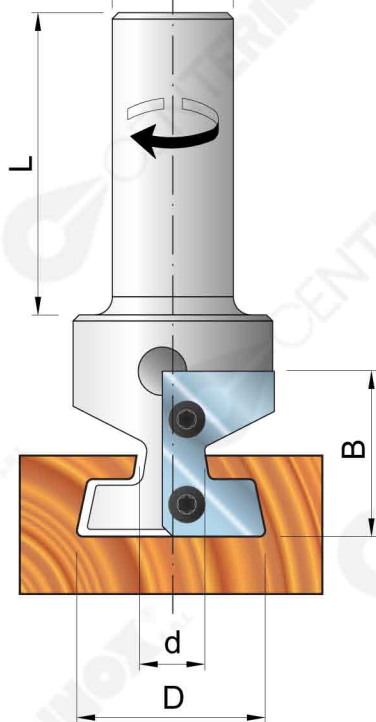

A

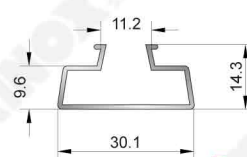
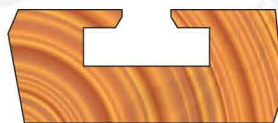

B

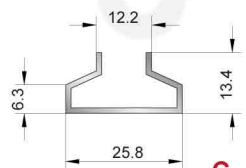

C

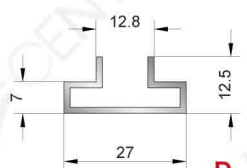
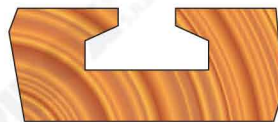

D

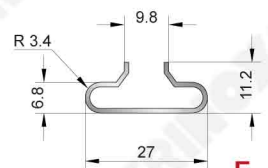
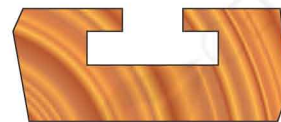

E

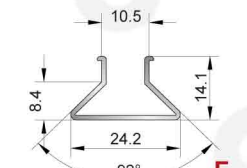

F

